

R14181

**VEGA**

24V  
DC



• **Tips**

This product shall be installed in accordance with local and national electrical regulations and by a licensed holder who is familiar with the construction and operation of the product.

Important! Before installing the lamp, please cut OFF the power or switch to "OFF" state;

Don't solder the connecting wire, please use the junction box.

Please do not place on the lamps and lanterns the decoration that does not come with the packing box.

Prevent Short circuit or overload.

Do not place heat insulation on the luminaire.

Mounted on a non-conductive surface.

Do not operate in an environment where the ambient temperature is higher than 40°C or lower than -20°C.

Ensure that the operating voltage used is within the voltage range indicated on the volume label.

Can only be installed in dry room.

The electric conductors of different kinds of lamps can not touch each other.

The light source in this luminaire can only be replaced by the manufacturer or its agent or a similar qualified person.

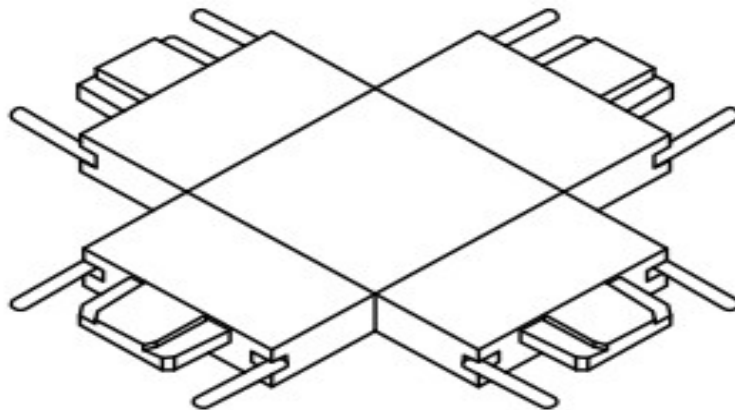

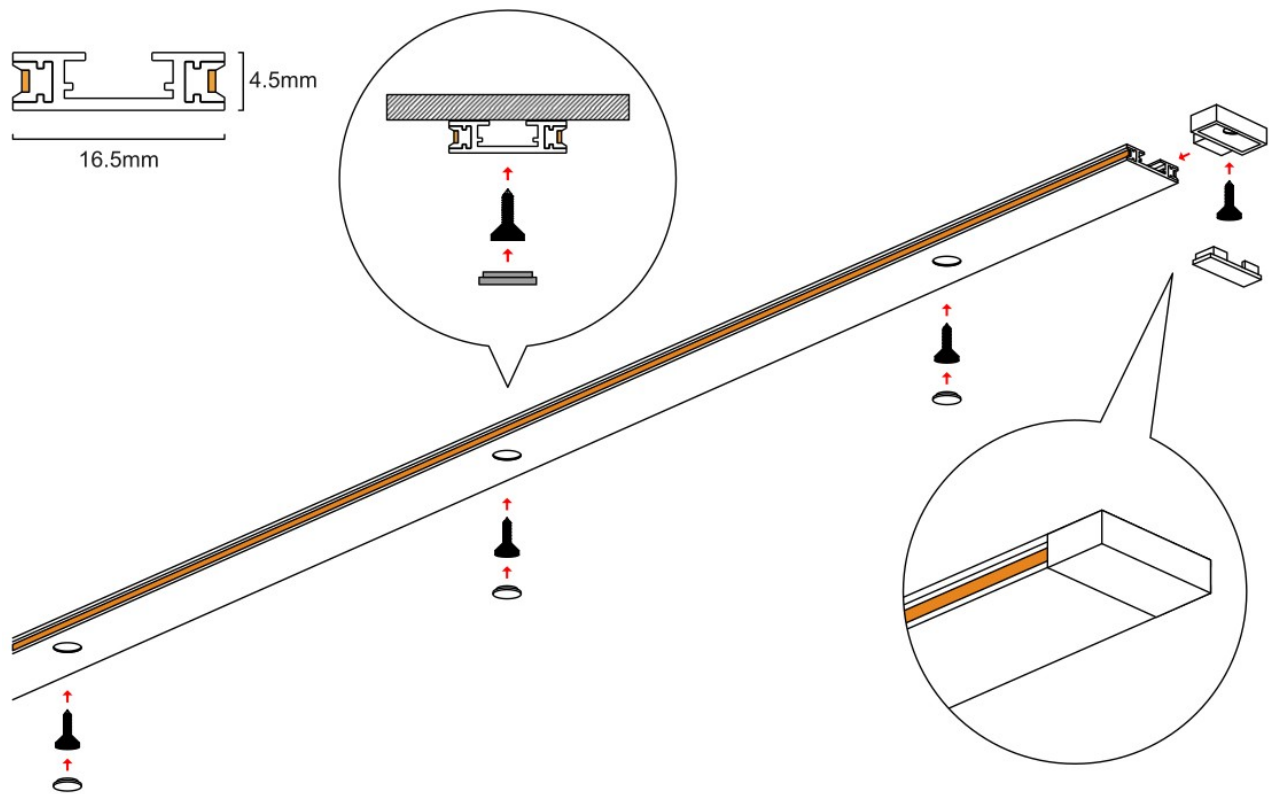

① Check that the accessories are complete:



Ultra-thin open mounted rail strips



+ screw



+ Screw hole cap

② According to the planned decoration scheme, install the track bar to the ceiling, screw it, install the "lid" to hide the screw hole.

③ Screw the 3 holes in each meter of the track bar until the whole track bar is fixed on the ceiling.

④ Finally, install the plug at the end of the track bar, fasten the screw, install the plug cover, and the track bar is installed.

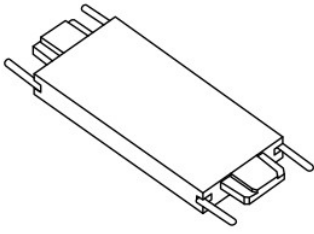

**I-splice**

The tracks are spliced and energized directly

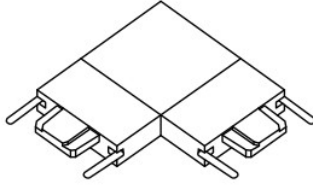

**L-splice**

The horizontal Angle of the track is spliced and energized

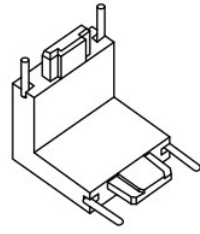

**perpendicularity L-splice**

The ceiling track is spliced with the wall track and electrified

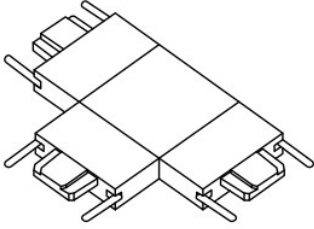

**T-splice**

The track is T-spliced and electrified

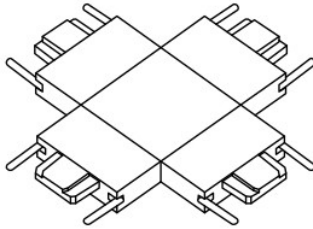

**X-splice**

The track cross is spliced and energized

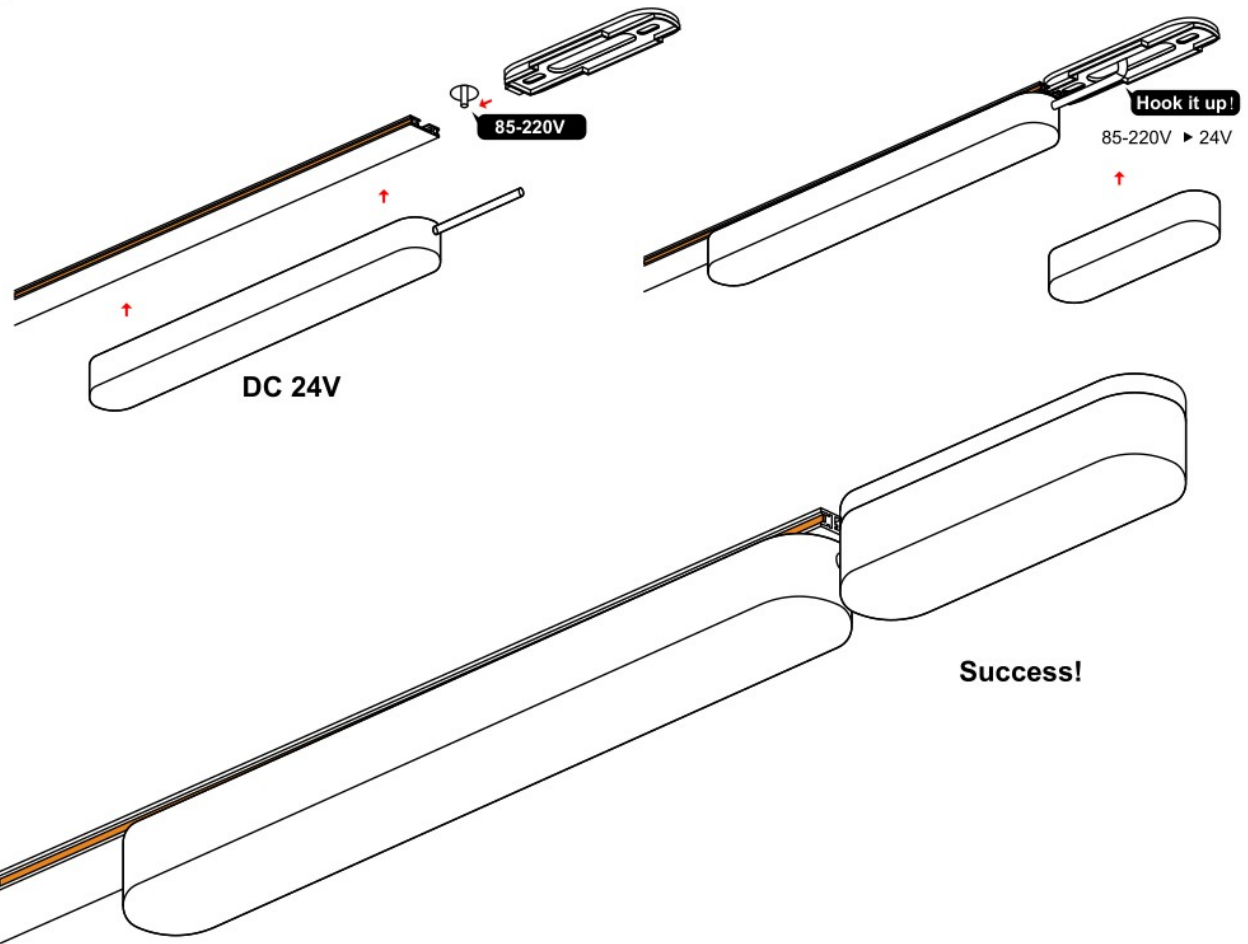
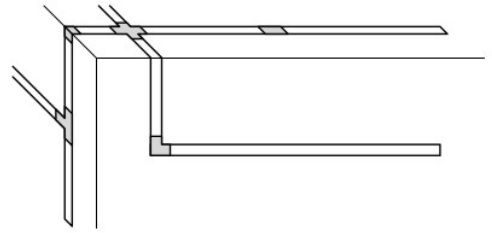

85-220V

Hook it up!

85-220V ▶ 24V

DC 24V

Success!

## **(EN) CAUTION!**

Turn off the main power at the circuit breaker before proceeding with the installation in order to prevent possible shock. The shade can easily be damaged, so please take care when handling. The important safeguards and instructions in this manual are not meant to cover all possible conditions and situations that may occur. A qualified installer must perform the installation.

## **(DE) ACHTUNG!**

Vor der Installation ist es notwendig, den Hauptstromkreis zu unterbrechen, um die Intervention von Stromschlag zu vermeiden. Vorsichtig Griff mit Leuchtschirm, weil es zerbrechlich ist. Wichtige Hinweise in dieser Installationsanleitung passen nicht alle möglichen Situationen, die entstehen können. Die Leuchte kann man nur von einer Fachmännische installiert werden.

## **(FR) ATTENTION!**

Éteignez l'alimentation principale au niveau du disjoncteur avant de procéder à l'installation afin d'éviter tout risque de choc. La nuance peut être facilement endommagée, alors soyez prudent lors de la manipulation. Les consignes de sécurité importantes et les instructions contenues dans ce manuel ne sont pas conçues pour couvrir toutes les conditions possibles et les situations possibles. Un installateur qualifié doit effectuer l'installation.

## **(CZ) UPOZORNĚNÍ!**

Před instalací je nutné odpojit hlavní elektrický okruh, aby se předešlo zasáhnutí elektrickým proudem. Se stínidlem manipulujte opatrně, protože je křehké. Důležité instrukce z tohoto instalačního manuálu neodpovídají všem možným situacím, které mohou nastat. Světlo může instalovat pouze způsobilá osoba.

## **(SK) UPOZORNENIE!**

Pred inštaláciou je nevyhnutné odpojiť hlavný elektrický okruh, aby ste predišli zasiahnutiu elektrickým prúdom. Stienidlom narábajte jemne pretože je krehké. Dôležité inštrukcie z tohto inštaláčného manuálu nezodpovedajú všetkým možným situáciám, ktoré môžu nastať. Svetidlo môže inštalovať iba spôsobilá osoba.

## **(HU) VIGYÁZAT!**

Telepítés előtt válassza le a fő elektromos áramkör az áramütés elkerülése érdekében. Óvatosan kezelje a lámpabúrát, mivel törékeny. A telepítési útmutató fontos utasításai nem felelnek meg az esetlegesen felmerülő helyzeteknek. A lámpatestet csak szakképzett személy szerelheti be.

## **(PL) OSTRZEŻENIE!**

Przed instalacją należy wyłączyć zasilanie, aby uniknąć porażenia prądem. Z kloszem należy obchodzić się ostrożnie, ponieważ jest krucho. Ważne instrukcje z tej instrukcji obsługi nie spełniają wszystkich możliwych sytuacji, które mogą się pojawić. Urządzenie może być instalowane wyłącznie przez osoby kompetentne.

## **(SE) VARNING!**

Stäng av strömmen innan installation påbörjas, för att inte riskera en elchock. Skärmen är bräcklig och bör därför hanteras extra varsamt. De viktiga säkerhetsåtgärderna och instruktionerna i denna manual är inte avsedda att täcka alla tänkbara förhållanden och situationer som kan uppstå. Installationen måste utföras av en el-certifierad person.

## **(DK) ADVARSEL!**

Sluk for jeres elektrisitet inden i installerer armaturet, på grund af risk for elektrisk stød. Skærmen til lampen er enkelt beskadigt, så vær venligst forsigtig ved håndtering af den. De sikkerhedsforanstaltninger og instruktioner som er i denne manual menes ikke at dække alle betingelser og situationer som kan opstå. Dette armatur må kun installeres af en kvalificeret elektriker.

## **(FI) VAROITUS!**

Katkaise päävirta katkaisijasta ennen asennuksen jatkamista estääksesi mahdollisen sähköiskun. Varjostin voi vahingoittua helposti, joten huomioi tämä käsitellessäsi tuotetta. Tämän oppaan turvallisuusohjeiden ei ole tarkoitus kattaa kaikkia mahdollisia

vaaratilanteita, joita voi sattua. Ammattitaitoisen asentajan tulee suorittaa asennustyö.

## **(HR) UPOZORENJE!**

Prije ugradnje potrebno je odspojiti glavni strujni krug, kako bi se izbjeglo intervenciji strujnog udara. Abažur nositi oprezno jer je krhak. Važne upute u ovom priručniku za postavljanje ne odgovaraju svim mogućim situacijama koje se mogu pojaviti. Svijetlo se može instalirati samo od strane stručne osobe.

## **(ES) ADVERTENCIA!**

Antes de la instalación, es necesario desconectar el circuito eléctrico principal para evitar la intervención de electrocución. Manipule con el forro de luminaria con cuidado porque es frágil. Las instrucciones importantes de este manual de instalación no coinciden con todas las situaciones posibles que pueden ocurrir. La luminaria solo puede ser instalada por una persona competente.

## **(PT) CUIDADO!**

Desligue a alimentação principal no disjuntor antes de prosseguir com a instalação para evitar possíveis choques. A sombra pode ser facilmente danificada, por isso, tenha cuidado ao manusear. As salvaguardas e instruções importantes neste manual não se destinam a cobrir todas as condições e situações possíveis que possam ocorrer. Um instalador qualificado deve executar a instalação.

## **(IT) ATTENZIONE!**

Spegner l'alimentazione principale dell'interruttore prima di procedere con l'installazione per evitare possibili scosse. L'ombra può essere facilmente danneggiata, quindi fare attenzione quando si maneggia. Le importanti misure di sicurezza e le istruzioni contenute in questo manuale non intendono coprire tutte le possibili condizioni e situazioni che possono verificarsi. Un installatore qualificato deve eseguire l'installazione.

## **(GR) ΠΡΟΣΟΧΉ!**

Πρίν την εγκατάσταση, απενεργοποιήστε την κύρια παροχή ρεύματος στον πίνακα ασφαλείας, για να αποφύγετε πιθανές ηλεκτροπληξίες. Το σκίαστρο μπορεί εύκολα να καταστραφεί, γι 'αυτό να προσέχετε κατά τη χρήση του. Οι σημαντικές διασφαλίσεις και οδηγίες στο παρόν εγχειρίδιο δεν γίνονται να καλύψουν όλες τις πιθανές συνθήκες και καταστάσεις που μπορεί να συμβούν. Ένας εξειδικευμένος ηλεκτρολόγος πρέπει να εκτελέσει την εγκατάσταση.

## **(NL) WAARSCHUWING!**

Schakel de hoofdstroomonderbreker uit voordat u doogaat met de installatie om mogelijke schokken te voorkomen. De kap kan gemaklijk worden beschadigd, wees dus voorzichtig tijdens de behandeling van het product. De instructies en veiligheidsmaatregelen in dit document zijn niet volledig voor alle mogelijke complicaties die kunnen optreden. Een gekwalificeerd persoon moet de installatie uitvoeren.

## **(BG) ВНИМАНИЕ!**

Преди монтиране на устройството е нужно да изключите тока, в мястото където работите, за да избегнете токов удар. С осветлителното тяло манипулирайте внимателно, за да избегнете повреда. Важни истукции от това ръководство за инсталация, не е задължително да отговарят на всички възможни ситуации, които могат да възникнат. Препоръчва се осветителното тяло да се вклучва от опитено за това лице.

## **(RO) ATENȚIE!**

Mai înainte de instalare, trebuie să deconectați circuitul electric principal pentru a preveni electrocutarea. Cu abajurul trebuie de manipulat cu atenție, este foarte fragil. Instrucțiunile importante din acest manual de instalare nu acoperă toate situațiile posibile care pot apărea. Acest corp de iluminat poate fi instalat numai de către o persoană calificată pentru acesta lucru.